

Rev	Note	CreatedBy	Appr.By	Appr.Date
A	Initial release	FG	AE	2020-06-10

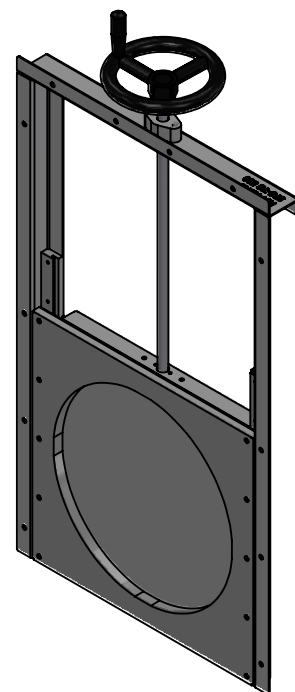
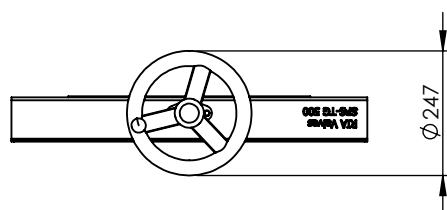
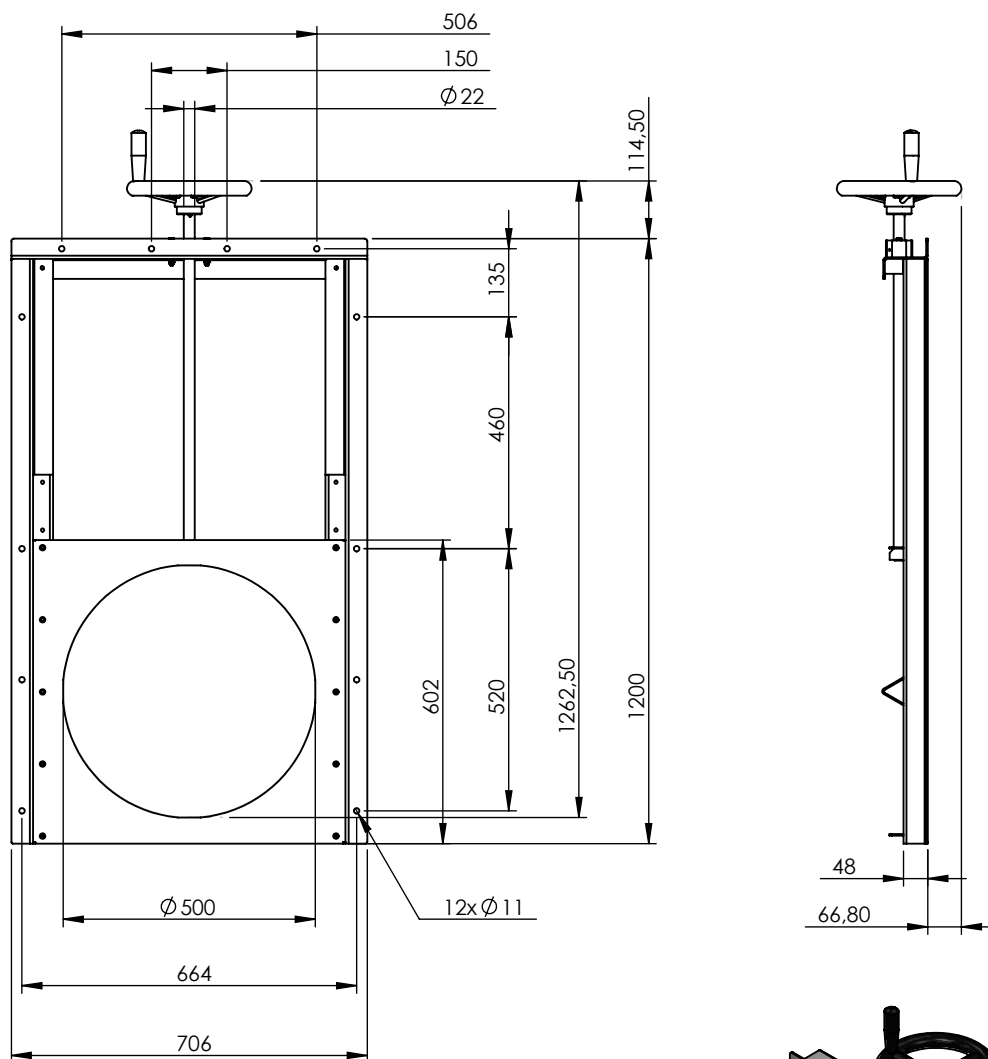

© 2018 Wapro AB. This document is subject to copyrights owned by Wapro AB. Any amendments, republication, retransmission, and/or reproduction of all or any part of the document is expressly prohibited, unless the copyright owner of the material has expressly granted its prior written consent. All other rights are reserved.

Designed By FG	Approved By AE	Created Date 2020-06-10	Units [mm]	General Tolerance SS-ISO 2768-1 m	Scale 1:15		
Material EN1.4404 / EN1.4301			Project			Comments	
Weight [kg] 33		Box Volume [m³]	Description WaGate SPS-TG DN500 Maximum pressure 3 mH2O				
 www.wapro.com			Article Number W2627_6500/4500	Drawing Number sps-tg dn500-en	Rev A	Sheet 1 (1)	